

50% of Actual Size
Direct Digital

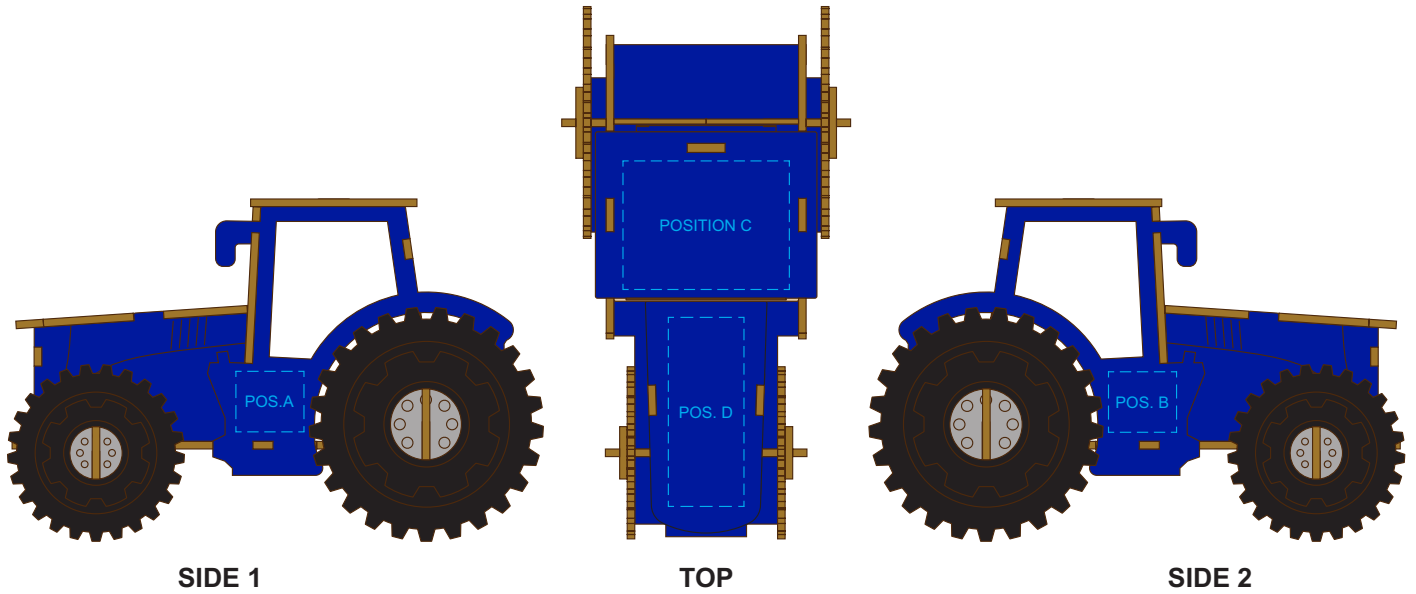

SIDE 1

TOP

SIDE 2

Up to a 2mm tolerance is expected for alignment of the printed artwork against the engraved lines.
Slight inconsistencies are to be considered acceptable if the artwork is printed over an engraved line.

Blue Line = Safe area for Artwork

100% of Actual Artwork Print Area

Customisable Colour Groups

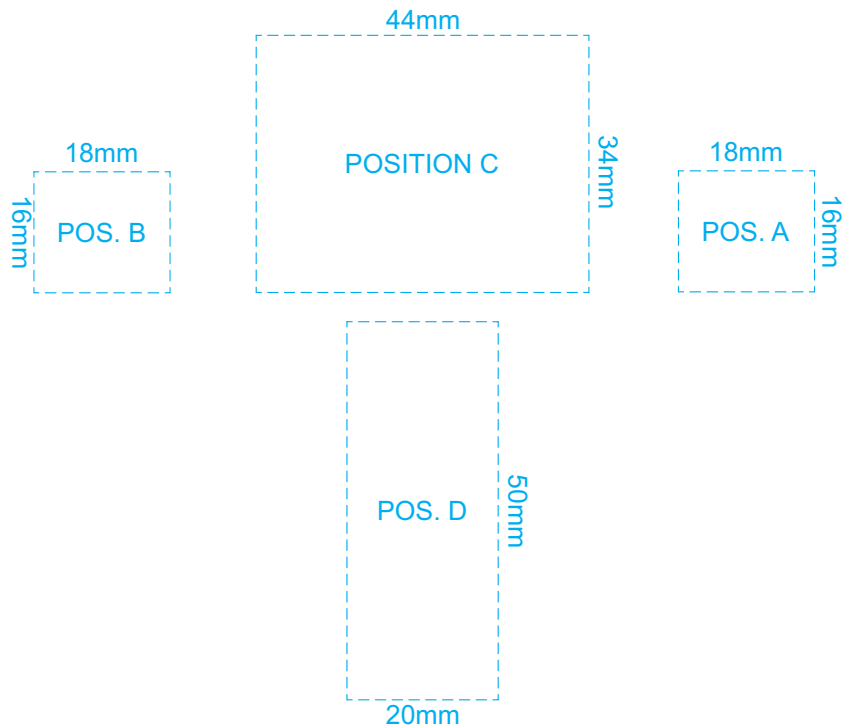

BRANDING SPECIFICATION - Tractor Wooden Model - 124026

Each colour group can be customised to any single colour. Please provide CMYK / PMS values (close matched) for each colour group or specify if solid colour fill is not required. The product is provided flat packed in a cardboard sleeve with assembly instructions.
For a fully customised design please refer to CUSTOM TEMPLATE below



70% of Actual Size
Direct Digital



 WOOD TONE (Not included in print)

Blue Line = Safe area for Arwork

Green Line = Engraved lines and Cut out lines on the board

Pink Line = Bleed off to here

50% of Actual Size
Direct Digital
(Custom Full Colour Design)

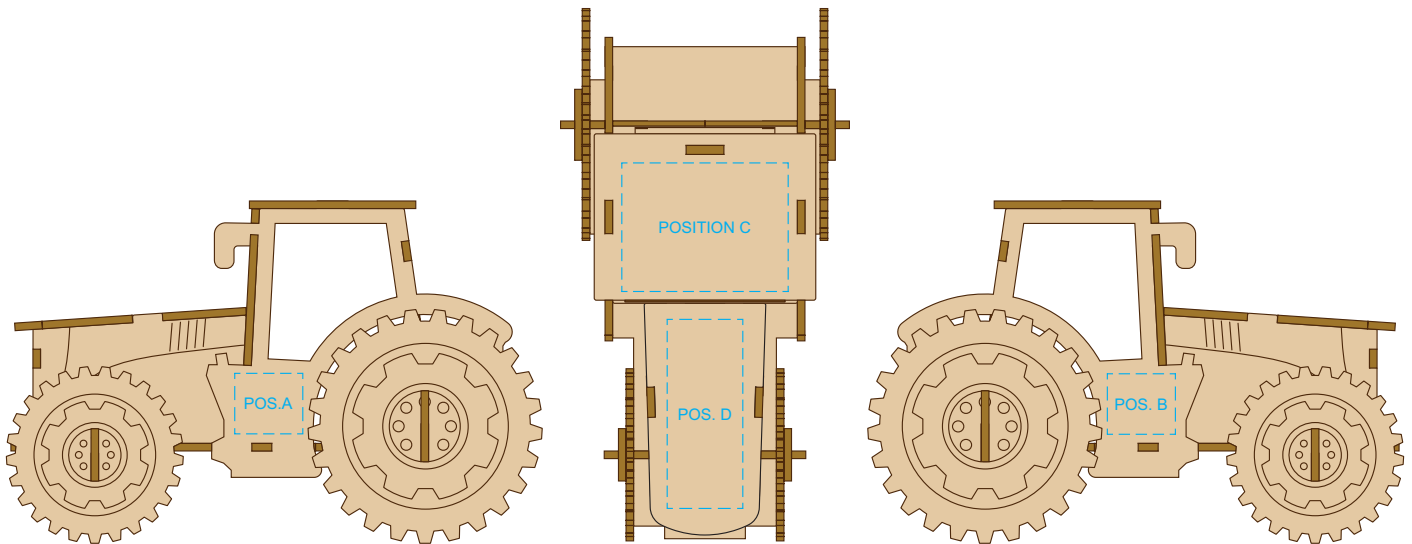

SIDE 1

TOP

SIDE 2

Up to a 2mm tolerance is expected for alignment of the printed artwork against the engraved lines. Slight inconsistencies are to be considered acceptable if the artwork is printed over an engraved line.

Blue Line = Safe area for Artwork

100% of Actual Artwork Print Area

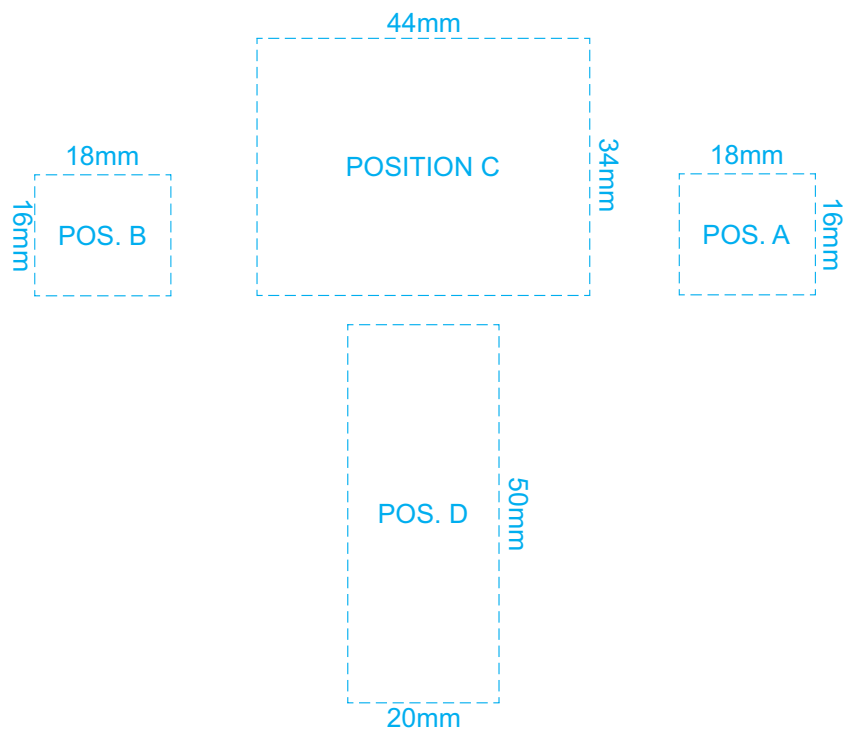

BRANDING SPECIFICATION - Tractor Wooden Model - 124026

A fully customised design can be done using this template. However, up to a 2mm tolerance is expected for alignment of the printed artwork against the engraved lines, cut outs and cut marks. All critical images and text need to be within the area marked by a blue line. Avoid all critical images & text within the area marked by a red line as they are cutouts which will be removed during assembly. Green lines are pre-engraved lines on the wooden sheet.

70% of Actual Size
Direct Digital
(Custom Full Colour Design)

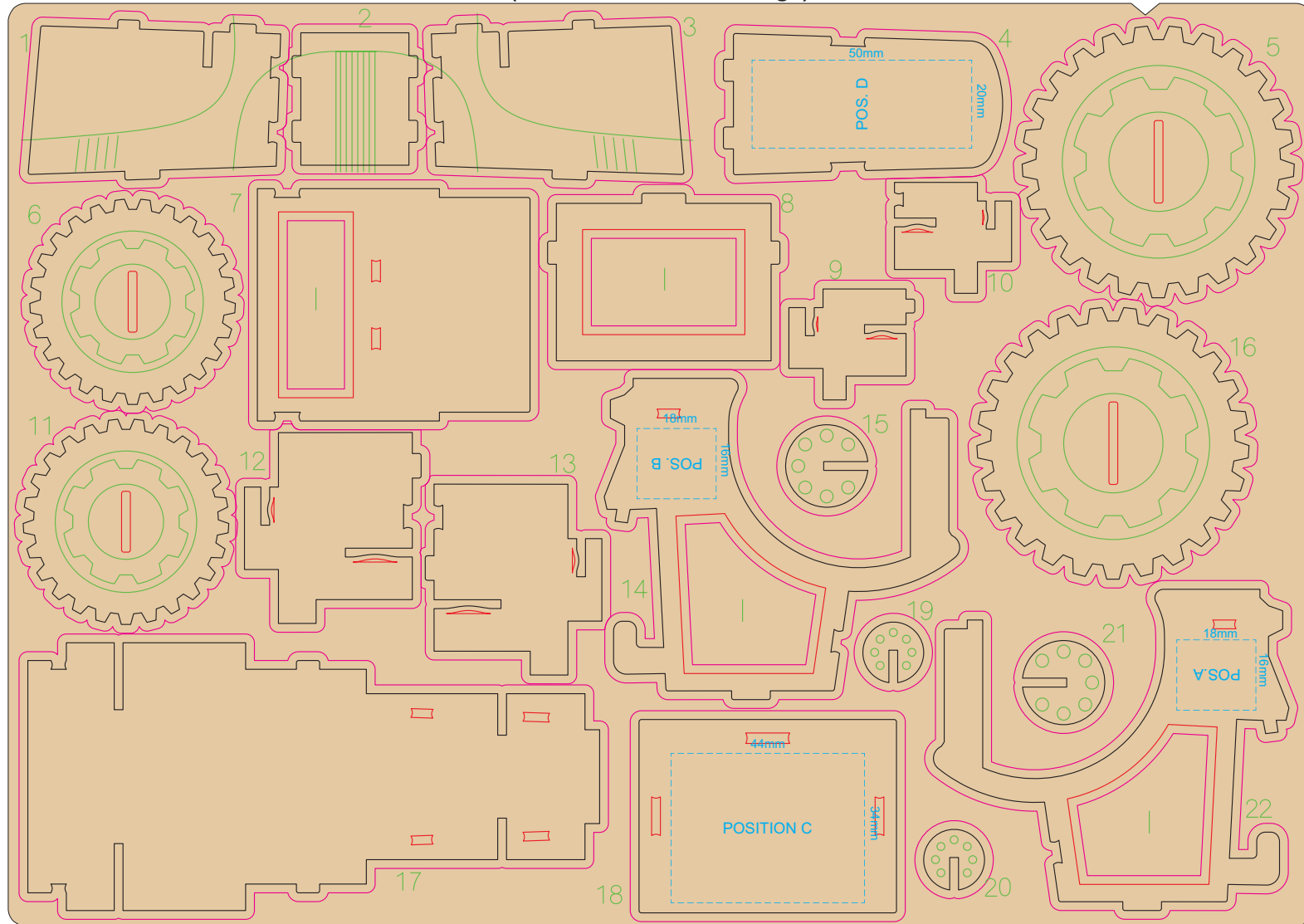

 **WOOD TONE** (Not included in print)

Blue Line = The SIGNIFICANT PRINT AREA
(Keep all critical images & text within this box)

Red Line = Cut outs

(Avoid all critical images & text within this area)

Green Line = Engraved lines on the board

Black Line = Cut Marks of Edges

Pink Line = Bleed off to here

50% of Actual Size
Screen Print (One Colour)

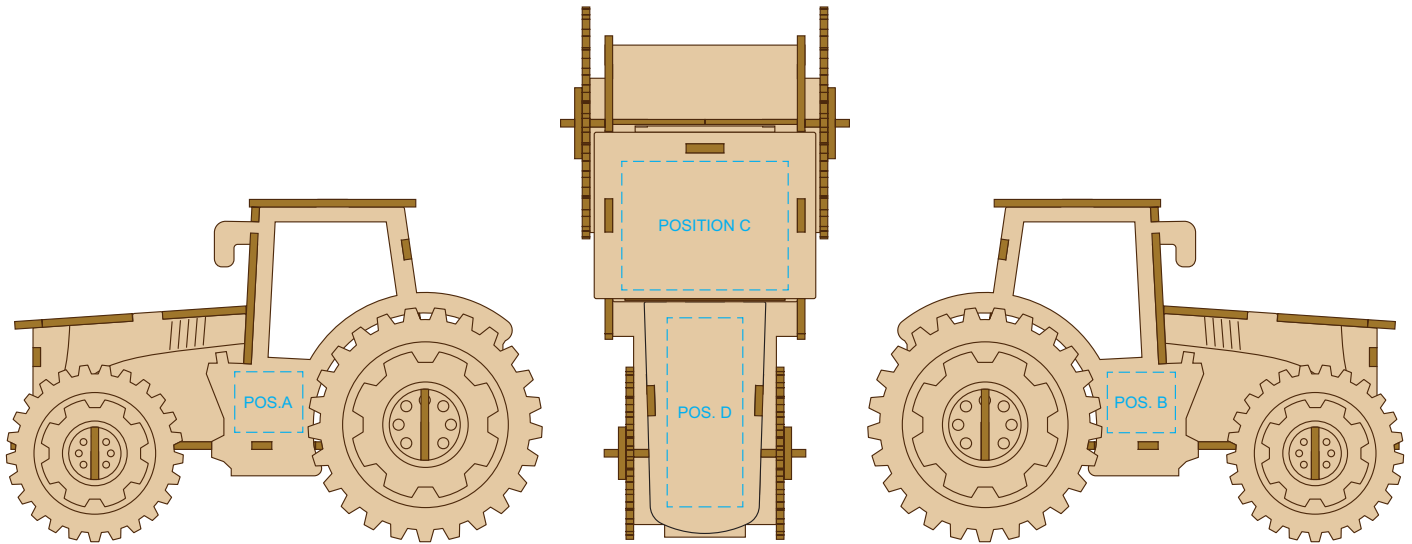

SIDE 1

TOP

SIDE 2

Up to a 2mm tolerance is expected for alignment of the printed artwork against the engraved lines. Slight inconsistencies are to be considered acceptable if the artwork is printed over an engraved line.

Blue Line = Safe area for Arwork

100% of Actual Artwork Print Area

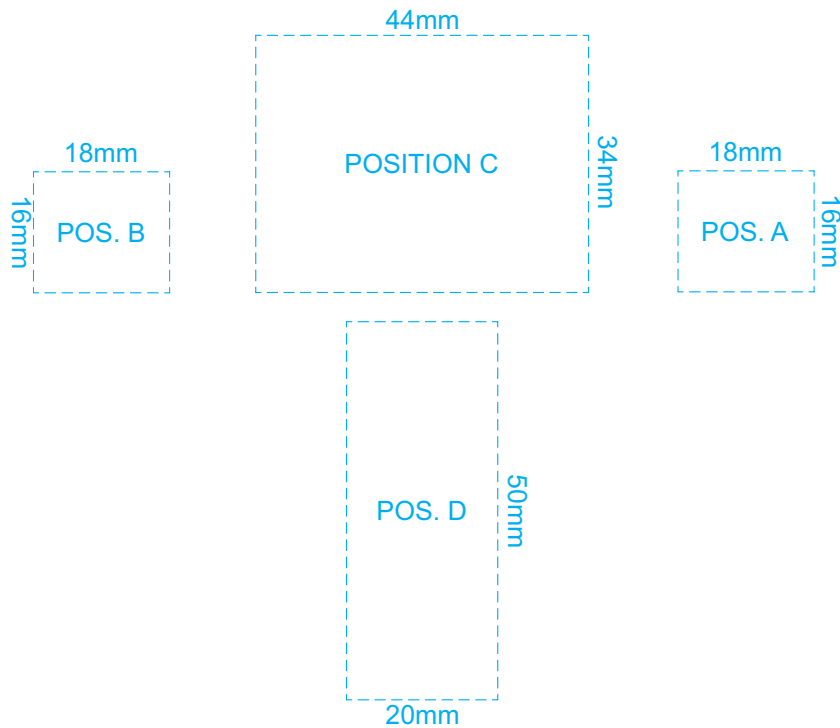

BRANDING SPECIFICATION - Tractor Wooden Model - 124026

This product is made from natural wood, therefore some slight colour variation are considered acceptable. The product is provided flat packed in a cardboard sleeve with assembly instructions.

50% of Actual Size
Laser Engraving

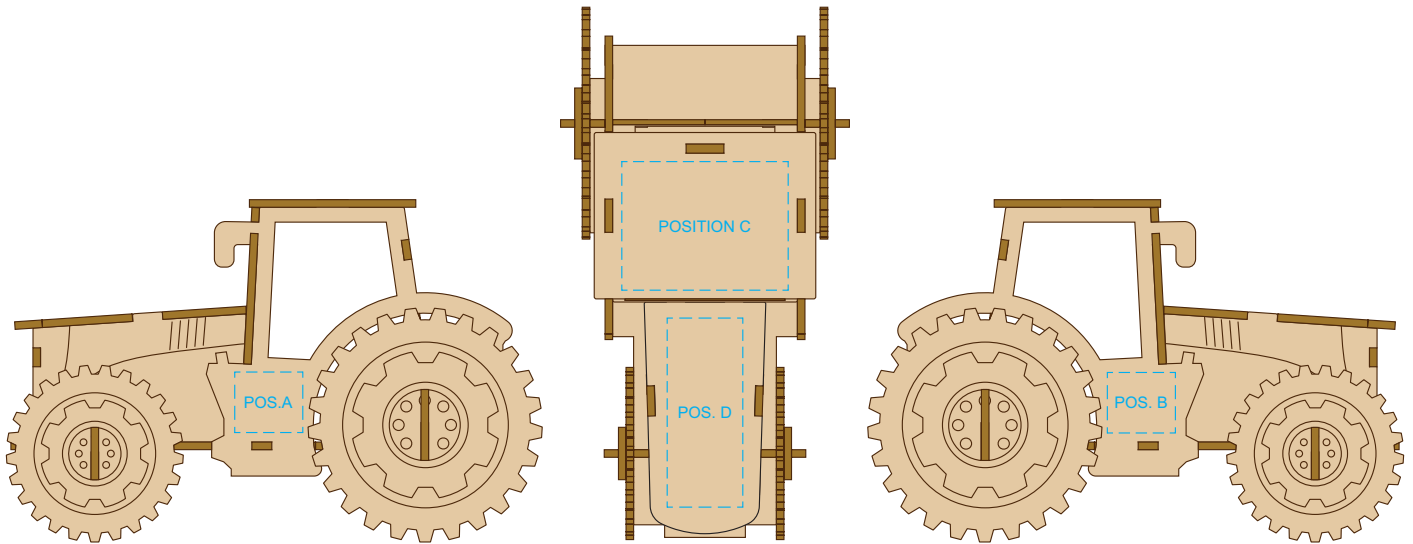

SIDE 1

TOP

SIDE 2

This product is a natural material, please allow for variances in grain pattern and engraving colour.
Up to a 2mm tolerance is expected for alignment of the printed artwork against the engraved lines.
Slight inconsistencies are to be considered acceptable if the artwork is printed over an engraved line.

Blue Line = Safe area for Arwork

 Laser engraves to a natural etch

100% of Actual Artwork Print Area

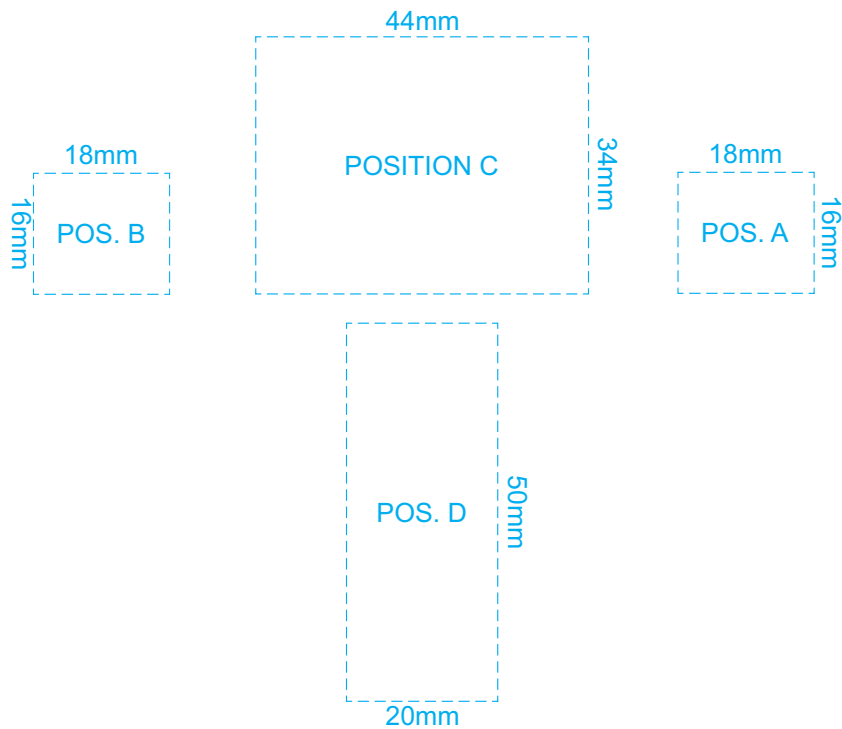

BRANDING SPECIFICATION - Tractor Wooden Model - 124026

This product is made from natural wood, therefore some slight colour variation are considered acceptable.
The product is provided flat packed in a cardboard sleeve with assembly instructions.

70% of Actual Size
Digital Packaging Print

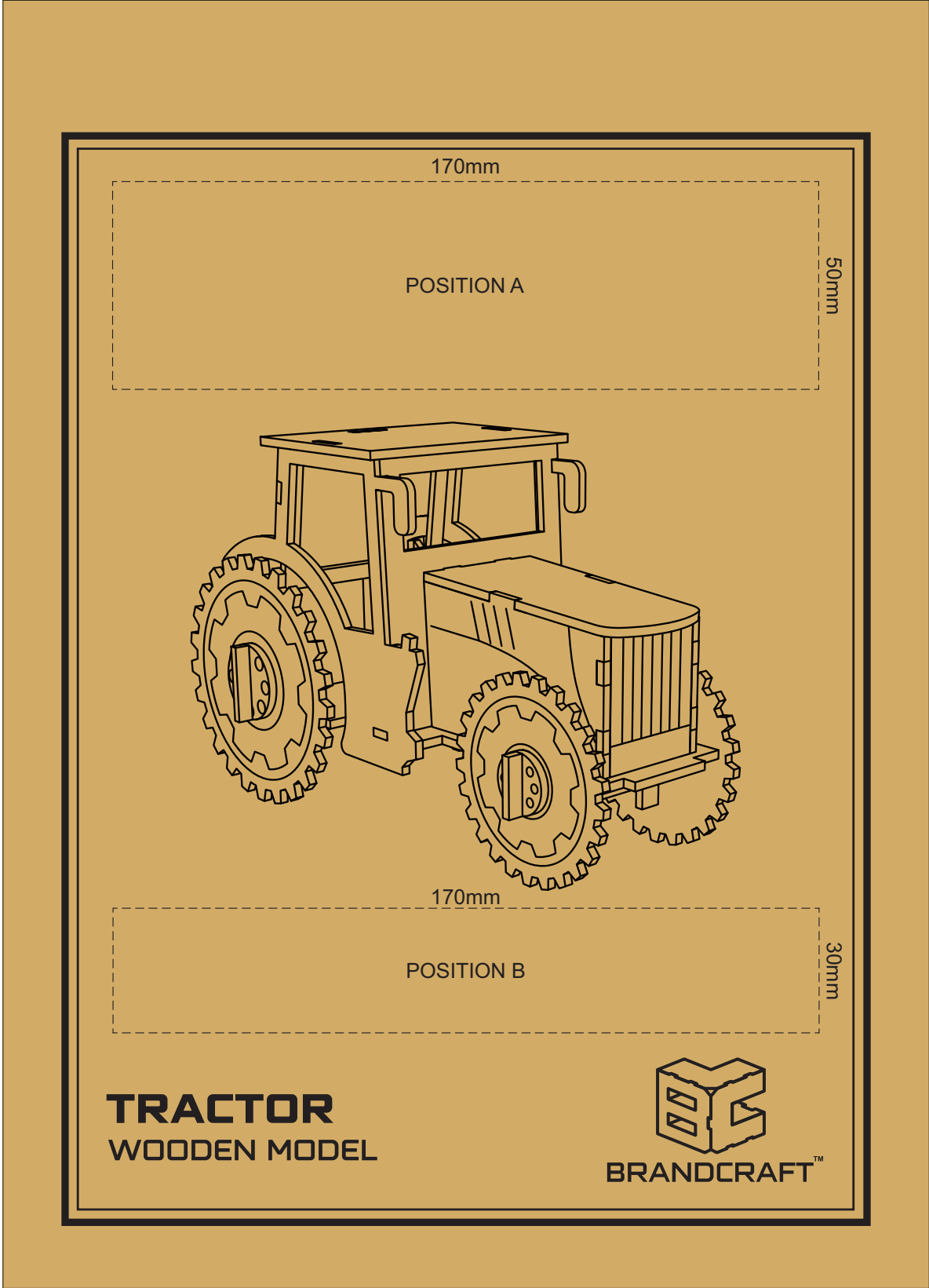

Artwork will be printed directly onto the product via CMYK printing (no white)
Colours will not be vibrant due to white ink not being available for this process.